

Article number: 4320000321

Description: Rota-fix shaft-hub connection A 32x60
Stainless Steel

Measures

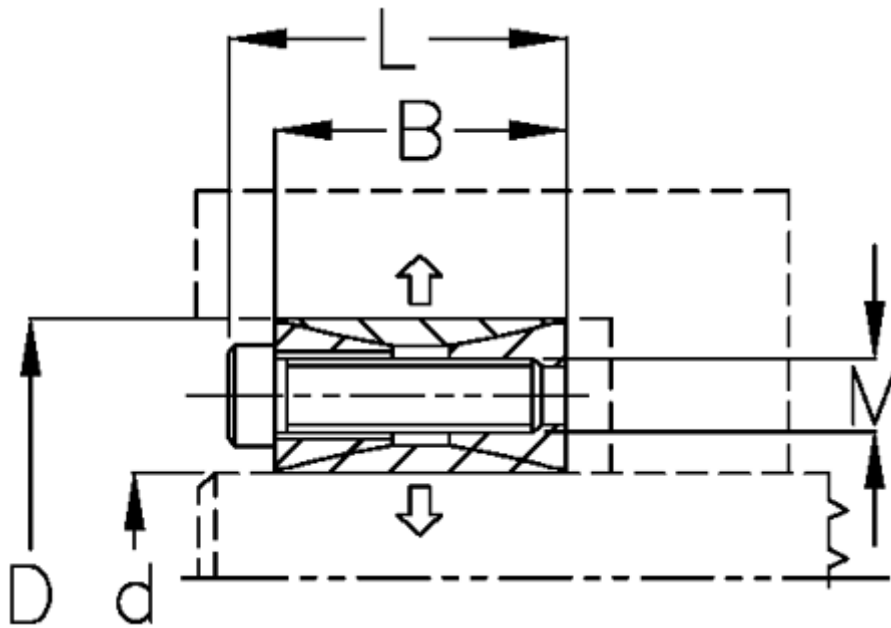

B mm	= 20
d H8 mm	= 32
D mm	= 60
Fit tolerance	= Aksel k11-h11, Nav N11-H11
F kN torque	= 24.7
L mm	= 26
M mm	= M6
P N/mm ² surface pressure on shaft/hub	= 37

Surface roughness	=
T N m torque	=
Ts N m bolt tightening torque	=